

Nikon

Photomic **F1TN**
FINDER

INSTRUCTION MANUAL





NOMENCLATURE

1. **Meter window:** houses the meter needle for exposure determination and battery checking
2. **Meter switch-off button**
3. **Meter switch-on button**
4. **ASA film-speed dial:** for setting the film speed from ASA 6–6400
5. **ASA scale index ring:** marked with a red triangular index and exposure correction scale for exposure compensation with certain lens-focusing screen combinations
6. **Shutter speed selector:** turns in either direction for setting the desired shutter speed
7. **Battery chamber cap**
8. **Coupling pin:** connects the meter mechanism to the lens diaphragm for full-aperture exposure measurement
9. **Finder lock lever:** press to remove or attach the finder
10. **Maximum aperture scale:** check to verify if the meter is set for the maximum aperture of the lens used
11. **Clamps:** for positioning the finder on the camera
12. **Viewfinder eyepiece:** accepts screw-in finder eyecup and eyepiece correction lenses
13. **Shutter speed index**
14. **Shutter speed scale**

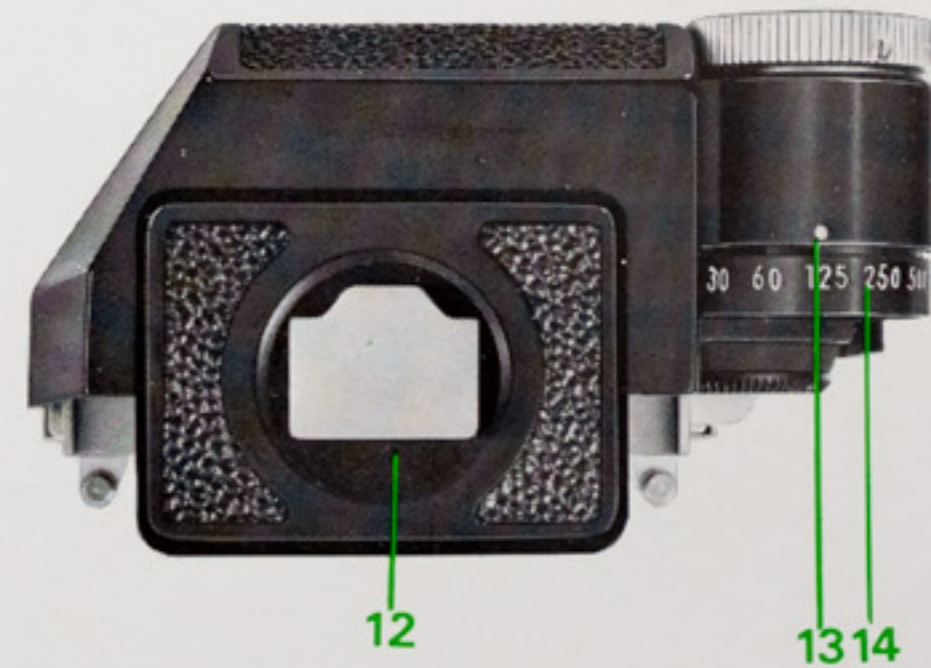
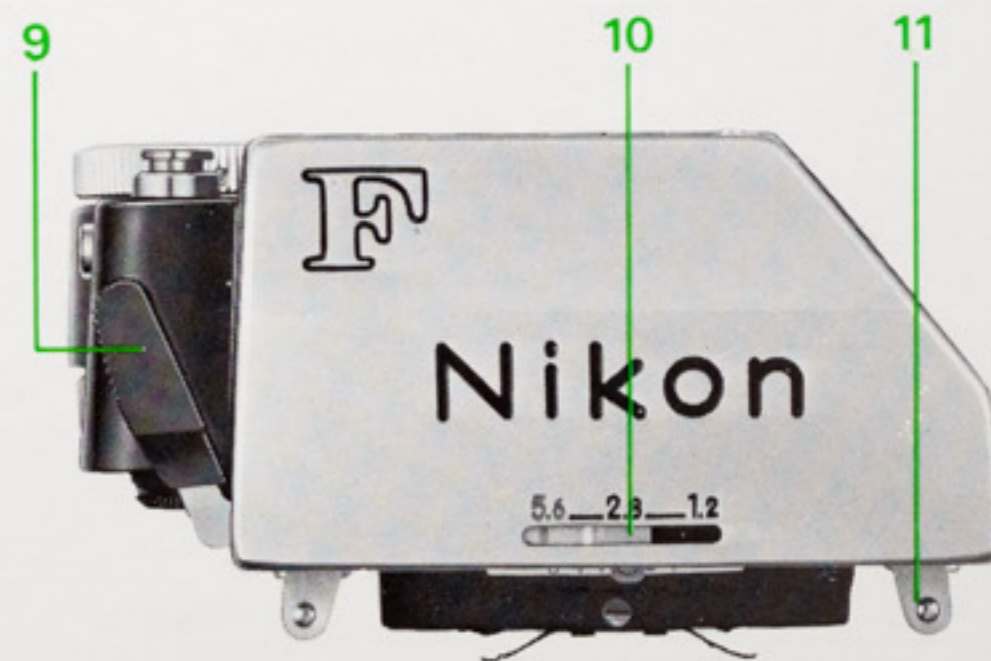
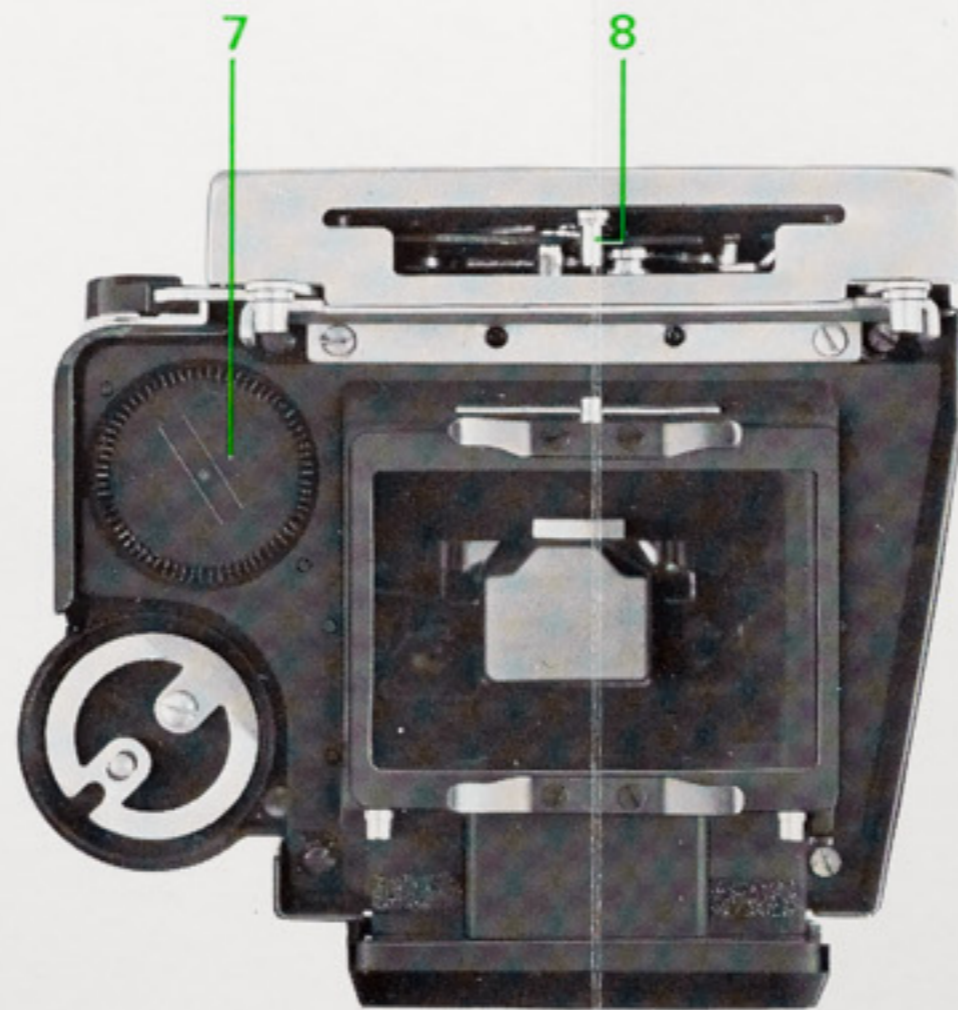
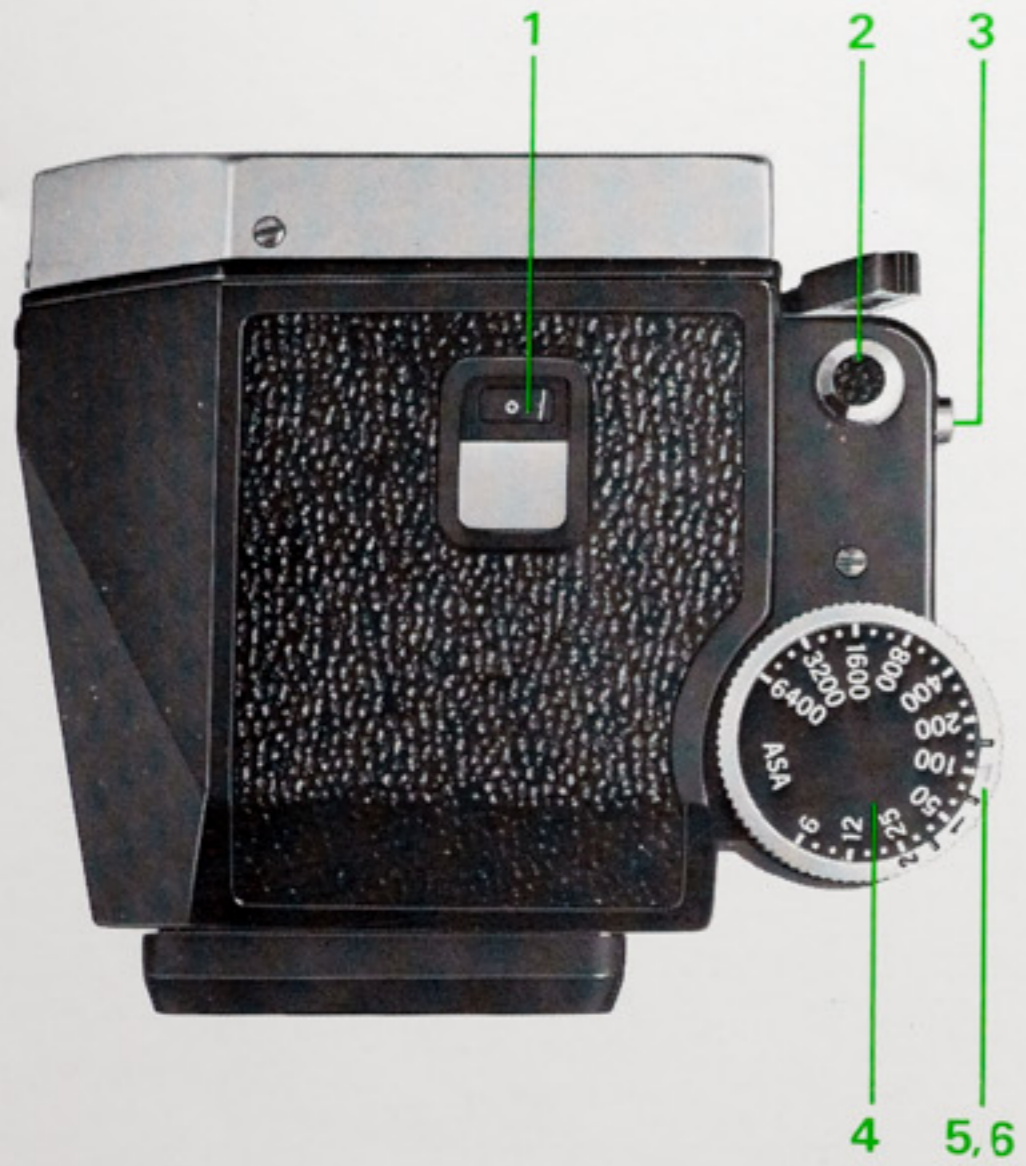

CONTENTS

Nomenclature	5
Foreword	7
Checking the Batteries	8
Attaching the Photomic FT _N Finder	9
Shutter Speed Coupling	
Lens Aperture Coupling	
Setting the Film Speed	
Turning On the Meter	
Exposure Measurement With the Photomic FT _N Finder . . .	14
Centering the Needle	
Getting the Right Exposure	
Measurement by the Stop-Down Method	18
Bellows Focusing Attachment, Extension Rings and Focusing Unit	
Preset Lenses	
Auto Lenses Without Coupling Prong	
Reflex-Nikkor Lenses	
Exposure Correction	20
Special Lens-Focusing Screen Combinations	
Repro-Copying	
Slide Copying	
Care and Handling	23
Features/Specifications	24
The Nikon Warranty	25

FOREWORD

The Nikon Photomic FT_N Finder incorporates a precise center-weighted CdS exposure meter which couples to the camera's lens aperture diaphragm and shutter speed controls. It makes possible easy, accurate thru-the-lens exposure measurement with the Nikon F.

This instruction booklet has been prepared to help you get the most out of your Photomic FT_N Finder. For best results, read the instructions carefully and keep this booklet handy for ready reference until you have mastered its basic steps. Follow the suggestions for care and handling on page 24 and you will get perfect exposures every time.

CHECKING THE BATTERIES

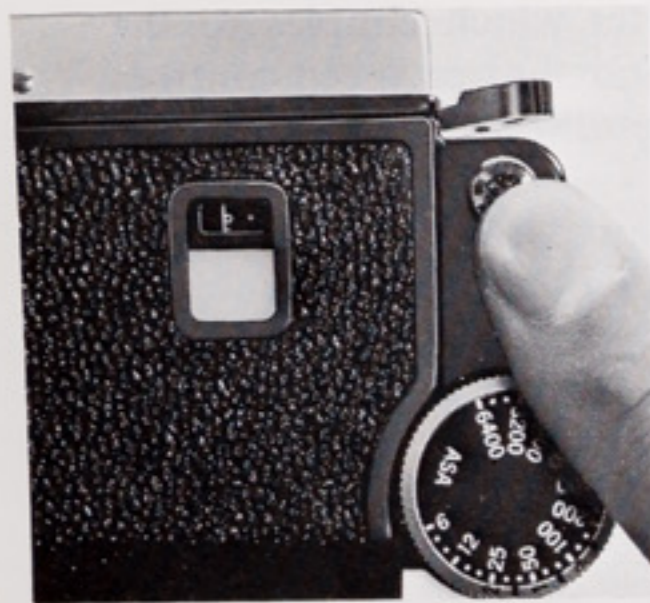

The Photomic FT_N Finder is powered by two 1.3 volt mercury batteries located in the battery chamber on the bottom of the finder. To check the batteries, press the meter switch-off button and observe the needle in the window on top of the finder. If the needle swings to the center circle or beyond, the batteries are in good condition. The two mercury batteries come installed with the Photomic FT_N Finder.

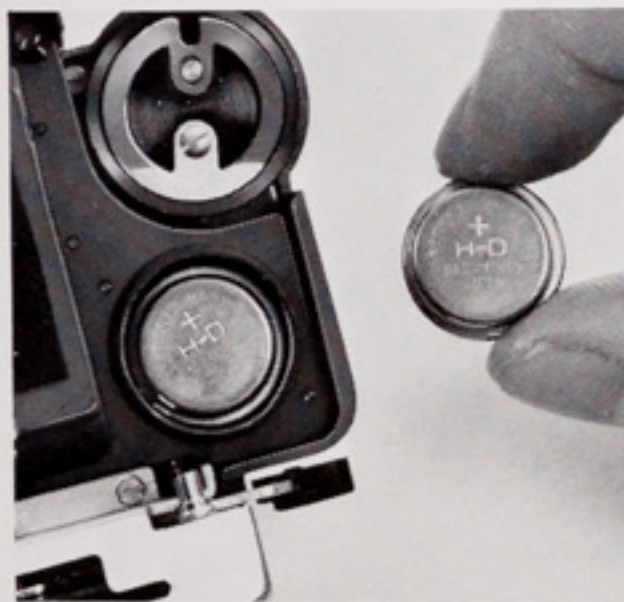

To replace weak or worn-out batteries, unscrew the cap over the battery chamber using a coin or key and the batteries will drop out. Make sure that the positive (+) side faces out when new batteries are installed.

Caution: Never throw discarded batteries into a fire as they will explode when heated.

ATTACHING THE PHOTOMIC FTN FINDER

To attach the finder to the camera with the lens in place, first set the diaphragm at f/5.6 and place the finder in position loosely. Then depress the finder lock lever and press down gently on the finder until it clicks into place. The Photomic FT_N Finder has a pair of pincer-type clamps on the bottom to hold it securely in place. They are loosened by depressing the finder lock lever.

Mounting the finder on the camera body without a lens is simple. Just depress the finder lock lever and press down gently on the finder until it clicks into place.

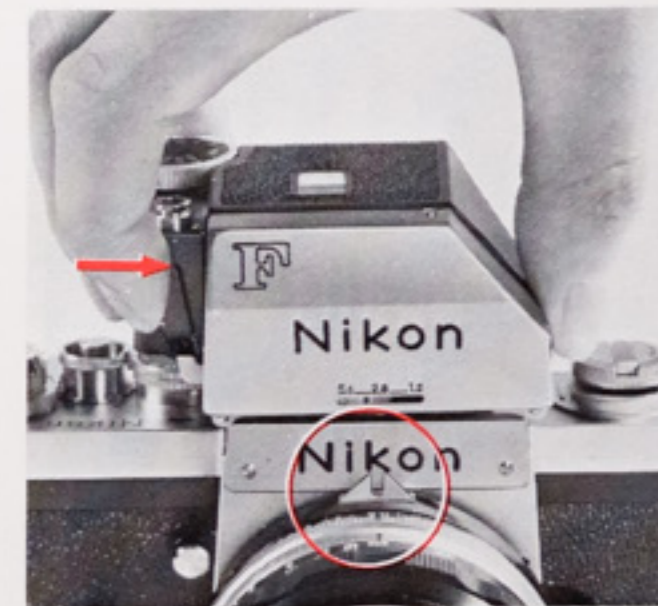

To remove the finder, depress the finder lock lever and press the finder release button located on the back of the camera. The finder will be unlocked and can be lifted out.

Note: When using flash, be sure to set the camera for flash by lifting up and turning the milled synchro-selector ring. Refer to the "Flash Synchronization" section in the Nikon F instruction manual.

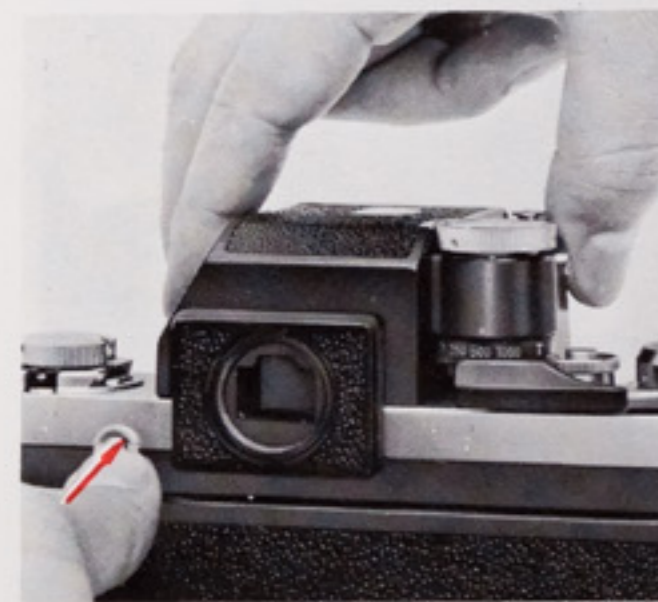

Shutter Speed Coupling

When the Photomic FT_N Finder is attached to the camera, the shutter speed dial on the camera is covered by the finder unit. Therefore, an auxiliary shutter speed scale is provided on the finder.

With the FT_N Finder in place, twist the shutter speed selector right and left until it engages the dial on the camera and the two rotate together.

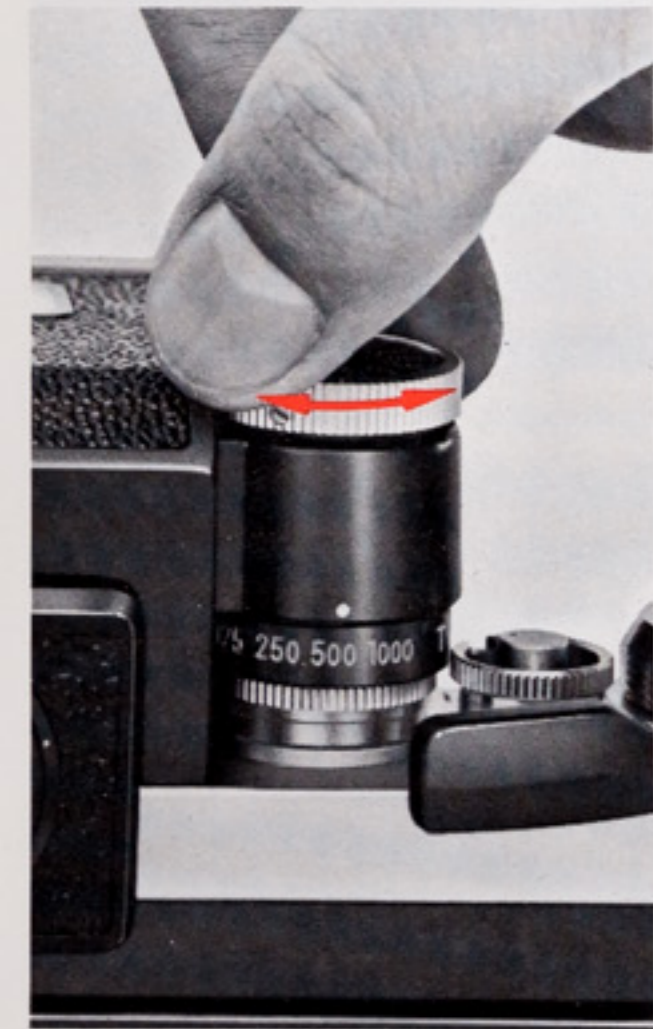

Lens Aperture Coupling

The Photomic FT_N takes advantage of the automatic diaphragm feature of Nikkor lenses to measure light with the lens wide open. Full-aperture metering gives a bright, clear finder image for viewing and focusing and minimizes the effect of light entering the viewfinder from the rear.

In order for the meter to measure exposure at full aperture with lenses of different maximum aperture, it must be coupled with the maximum aperture of the lens in use. This is done each time the lens is attached or changed by turning the aperture ring of the lens through its entire range.

With the lens mounted on the camera, twist the aperture ring counterclockwise, then clockwise as far as it will go. This meshes the coupling prong on the lens with the pin on the Photomic FT_N Finder and adjusts the meter for the maximum aperture of the lens.

The adjustment can be verified by checking the maximum aperture scale on the front of the finder. The scale has a range from f/1.2 to f/5.6. For example, if the 50mm f/1.4 lens is mounted on the camera, the red index mark should appear between 1.2 and 2.8.

For instructions for mounting and removing lenses, see the Instruction Booklet for the Nikon F.



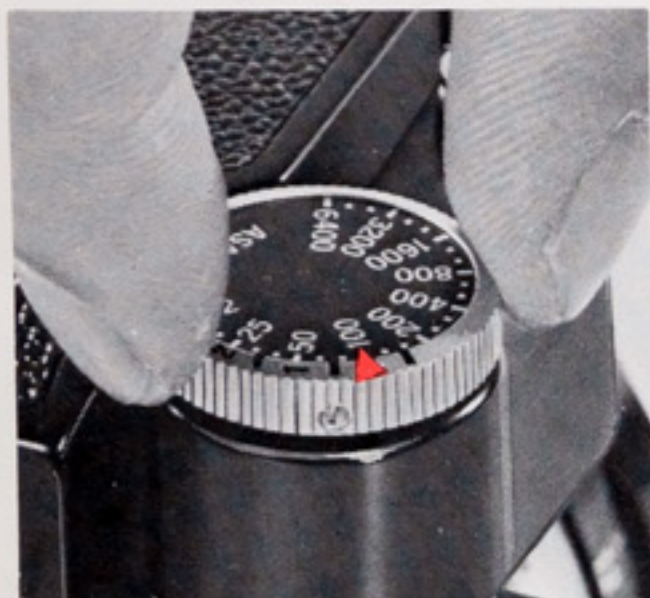

Setting the Film Speed

Lift and turn the milled ring around the ASA film speed dial so that the red triangular index mark on the ring lines up with the number corresponding to the ASA rating of the film loaded in the camera. The film speed dial covers a range from ASA 6 to 6400. There are two dots between each pair of numerical marks for intermediate settings such as ASA 64, 80, 125, etc.



Turning On the Meter

Switch on the meter circuit by pressing in the meter switch-on button located on the side of the finder. The meter switch-off button will then pop up and a red line around its circumference will be visible. This serves as a warning that the meter is on.

To turn off the meter, depress the top button until the red line is no longer visible and the meter switch-on button on the side of the finder pops out. Do not leave the meter on for long periods of time unnecessarily since the batteries are being drained as long as it is turned on.



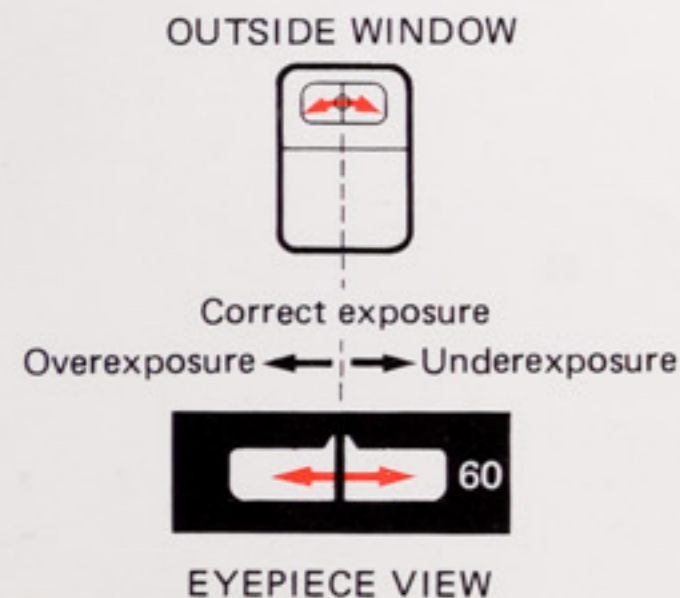

The Photomic FTN uses a center-weighted thru-the-lens metering system that reads the light over the entire focusing screen but favors the central portion of the screen. This means that it is possible to get correct exposure in situations where an averaged reading of the entire screen would result in underexposure of the main subject—with strongly backlit portraits, for example. And since measurement is always done at full aperture with Auto Nikkor lenses, the viewfinder image is bright and clear.

The amount of light reaching the film (exposure) is determined by a combination of lens aperture and shutter speed. Since the two are interrelated, different combinations will give the same amount of exposure. For example, 1/500 second at f/2 is the same as 1/30 second at f/8.

The choice of aperture and shutter speed depends on the results desired. Choose a fast shutter speed to “freeze” motion, a slow one to create deliberate blur. Use a small lens aperture for wide depth of field or a large one to make the main subject stand out and throw unimportant background out of focus.

Centering the Needle

The correct exposure is found by centering the meter needle, either in the V-shaped notch which is visible in the viewfinder or at the central mark located beneath the window on top of the finder. Turn either the shutter speed selector or lens aperture ring until the needle is centered. For fine adjustments of less than one f/stop, use the lens aperture ring, since it provides reliable intermediate settings between the marked f/numbers. The shutter speed selector is not set for intermediate values.

As an added convenience, the shutter speed in use appears in the viewfinder, so the shutter speed can be adjusted while observing the exposure meter needle. In dim light, the accessory Photomic Illuminator DL-1 illuminates the meter needle and shutter speed for easy reading. Under extremely low light conditions, the meter needle may center at the “B” setting on the shutter speed selector. If so, the correct exposure time is two seconds. If the needle centers at “T,” exposure time is four seconds.

If the needle cannot be centered or still moves erratically after all possible aperture-shutter speed combinations have been tried, then the light is too bright or too dim for the meter. The meter’s effective range (coupling range) varies according to lens used and film speed. For example, with the 50mm f/1.4 lens and film rated at ASA 100, it extends from f/1.4 at 1/2 second to f/11 at 1/1000 second.

Note: If the meter is exposed to bright light at below-freezing temperature, it may malfunction or cease to operate until the temperature rises again. Therefore, be careful not to leave the meter turned on for more than three minutes at a time in cold weather.

Getting the Right Exposure

The central part of the focusing screen should always be aimed at the main subject when centering the needle. Otherwise unimportant bright or dark areas may influence the exposure reading.

If an off-center composition is desired, first measure the light striking the main subject and set the aperture and shutter speed to center the needle. Then move the camera until the desired composition appears in the viewfinder.

For subjects of uniform brightness, a reading may be taken from any part of the subject. However, if the subject is contrasty (sidelighted portraits, for example), measure the light falling on the most important part of the subject in which detail is desired in the final picture. For landscapes including large areas of sky, tilt the camera downward during measurement or fill the center of the finder with the main subject to prevent overexposure caused by the bright skylight, otherwise the main subject will be underexposed.

Keep Out Stray Light!

The Photomic FTN Finder is designed to minimize the effect of light entering through the finder eyepiece under normal picture-taking conditions. However, in the following situations the use of a finder eyecup is recommended to insure complete exclusion of stray light.

- When the stop-down method of exposure measurement is used at small apertures
- When the camera is in sunlight and the subject is in shade
- When a shaft of sunlight falls between the eye and the eyepiece

When the needle on top of the finder is used to determine exposure, the eyepiece should be covered with the hand to prevent extraneous light from entering the finder.



Measuring the bright area in the center of the screen will cause underexposure of the main subject.

Exposure measurement area 

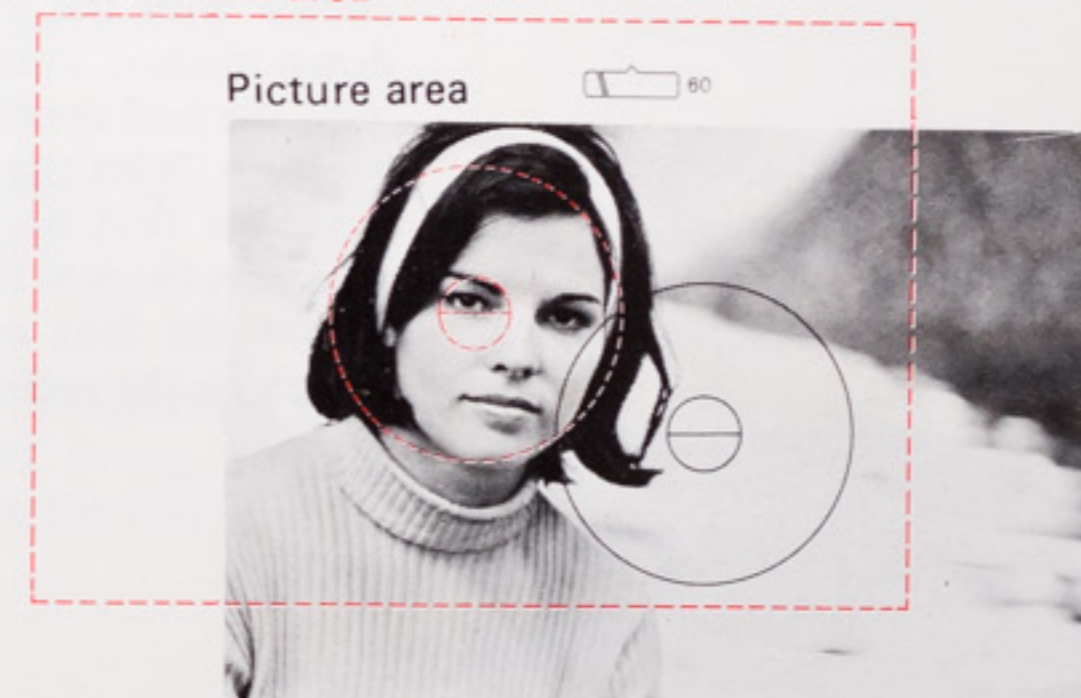

For correct exposure, first measure the light striking the main subject, then compose and shoot.

With the following lenses and accessories full-aperture exposure measurement is not possible, either because the lens has no auto-diaphragm or because the diaphragm will not couple with the Photomic FT_N meter. Therefore, the stop-down method must be used. This means measuring exposure with the lens aperture diaphragm stopped down to the taking aperture. With the Photomic FT_N finder, the meter coupling pin must first be pushed up into the finder so that the red index on the maximum aperture scale springs to f/5.6.

Mount the lens or lens/accessory setup to the camera and switch on the meter in the usual way.

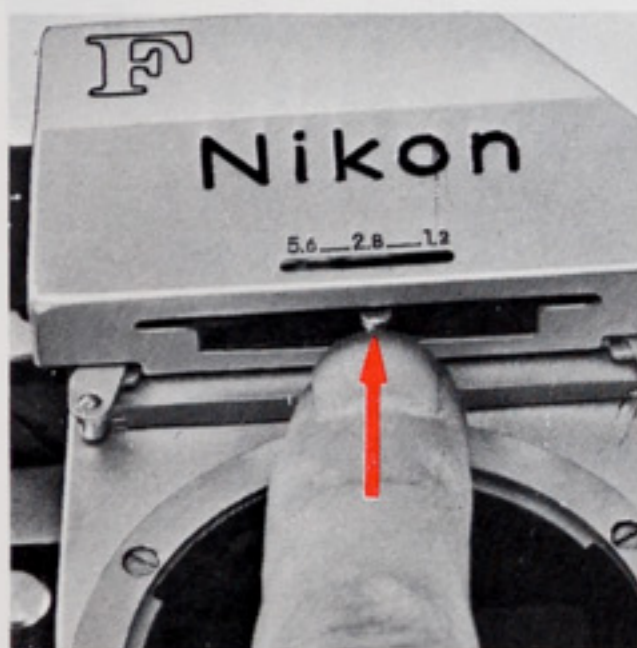

Bellows Focusing Attachments, Extension Rings and Focusing Unit

To determine exposure, select the desired shutter speed and stop down the lens manually until the needle centers.

Preset Lenses

Use the same procedure as above for lenses having preset diaphragms, such as the PC-Nikkor 35mm f/2.8.

Auto Lenses Without Coupling Prong

Some lenses like the Zoom-Nikkor Auto 200-600mm f/9.5 have an auto diaphragm but no coupling prong. Use the depth-of-field preview button to stop down the lens until the needle is centered.

Reflex-Nikkor Lenses

The Reflex-Nikkor 500mm f/8, 1000mm f/11 and 2000mm f/11 lenses have no aperture diaphragm. Adjust the shutter speed until the needle is centered.

Note: Since focusing may be difficult or impossible at small apertures due to image darkening on the screen, first open the lens to full aperture to focus. Then determine the correct exposure by the stop-down method.

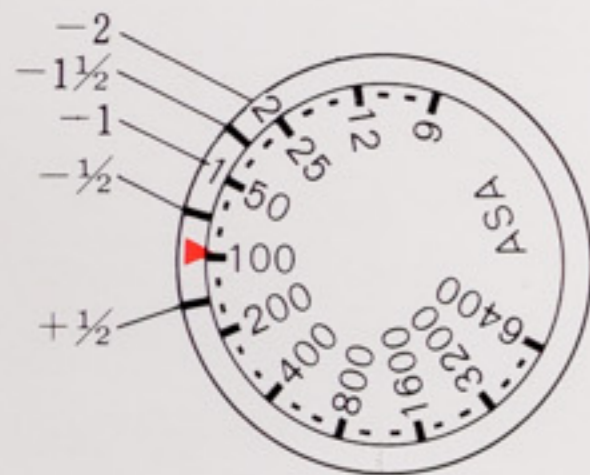

Special Lens-Focusing Screen Combinations

Because the light-transmitting properties of some focusing screens differ from those of ordinary screens, certain lens-screen combinations require exposure correction to compensate for the influence of the screen. Compensating marks from -2 to $+1/2$ are engraved around the ASA film speed dial. Correct settings are given in the table at right.

The numbers in the table indicate the exposure corrections to be made in f/stops: this means you have to stop down or open up the lens diaphragm according to the indicated numbers.

With the Photomic FT_N meter, however, exposure compensation is automatic at all aperture settings when the proper mark on the ASA scale index ring is set opposite the film speed dial. If exposure correction is required, line up the proper marking opposite the number corresponding to the film speed. For example, the table indicates a half-stop decrease ($-1/2$) for the 135mm f/3.5 lens with Type C screen. If the film speed is ASA 100, line up the number 100 on the film speed dial opposite $-1/2$ mark. When no exposure correction (0) is indicated, the ASA rating for the film in use should appear opposite the red triangular index.

■ — Measure exposure by the full-aperture method.

■ — Use the stop-down measuring method.

■ — Neither method will work. With these lens-screen combinations the viewfinder can be used only for focusing, not exposure measurement.

Combinations represented by a blank space are unusable because of image darkening or considerable moire over the screen area.

Lens		Screen																
		A/L	B	C	D	E	G1	G2	G3	G4	H1	H2	H3	H4	J	K/P	M	R
Fisheye	6mm f/2.8	0	0	-1/2	-1/2	0	0	0				0	0		0	0		
	8mm f/2.8	0	0	-1/2	-1/2	0	0	0				0	0	0	0	0		
	16mm f/3.5	0	0			0	0					0	0	0	0	0		
Wideangle	15mm f/5.6	0	0			0		-1				0			0	0		0
	20mm f/3.5	0	0			0	-1/2					-1/2			0	0		0
	24mm f/2.8	0	0			0		0				0	0		0	0		0
	28mm f/3.5	0	0			0	-1/2					-1/2			0	0		0
	28mm f/2	0	0			0	+1/2	0				+1/2	0		0	0		0
	35mm f/2.8	0	0			0	0					0	0		0	0		0
	35mm f/1.4	0	0			0	+1/2	+1/2				+1/2	+1/2		0	0		0
Normal	50mm f/2	0	0			0	+1/2	+1/2				+1/2	+1/2		0	0		0
	50mm f/1.4	0	0			0	+1/2	+1/2				+1/2	+1/2		0	0		0
	55mm f/1.2	0	0			0		0					+1/2		0	0		0
Telephoto	85mm f/1.8	0	0			0		+1/2					0		0	0		0
	105mm f/2.5	0	0			0		0				+1/2	+1/2		0	0		0
	135mm f/3.5	0	0	-1/2	-1/2	0		0				+1/2	+1/2		0	0		0
	135mm f/2.8	0	0	-1/2	-1/2	0		0				0			0	0		0
	180mm f/2.8	0	0	-1/2	-1/2	0						0			0	0		0
	200mm f/4	0	0	-1/2	-1/2	0		-1-1/2				-1/2		0	0	0		0
	300mm f/4.5	0	0	-1/2	-1/2	0							-1		0	0		0
	400mm f/5.6	0	0	0	0	0								-1-1/2	-1-1/2	0	0	0
	400mm f/4.5	0	0	0	0	0									0	0		0
	600mm f/5.6	0	0	0	0	0									0	0		0
Zoom	800mm f/8	0	0	0	0	0									0	0		0
	1200mm f/11	0	0	0	0	0									0	0		0
	43~86mm f/3.5	0	0			0		-1/2					-1/2		0	0		0
	50~300mm f/4.5	0	0			0									0	0		0
	80~200mm f/4.5	0	0			0									0	0		0
GN	45mm f/2.8	0	0			0	0							0	0		0	
Micro-P	55mm f/3.5	0	0			0						0		0	0		0	
PC	35mm f/2.8	0	0			0								0	0		0	
Bellows	105mm f/4	0	0	0	0	0								0	0		0	
Medical	200mm f/5.6	0	0			0								0	0		0	
Reflex Telephoto	500mm f/8	0	0	0	0	0								0	0		0	
	1000mm f/11	0	0	0	0	0								0	0		0	
	2000mm f/11	0	0	0	0	0								0	0		0	

Repro-Copying

For originals such as photographs which have tonal gradations, exposure is determined in the usual way.

In the case of originals having strong contrast and no gradation, such as documents or line drawings, measure the brightness of the white portion of the original (if the original is predominantly black, a sheet of white paper may be substituted) after decreasing the film speed by four marks. Or open up the lens about 1-1/3 stops.

Slide Copying

For originals with continuous tonal gradations, determine exposure in the usual way by the stop-down method. To copy slides with letters or figures on a transparent background, decrease the film speed four marks, or open up the lens about 1-1/3 stops. In the case of transparent figures or letters on a dark background, either increase the film speed five marks or stop down the lens about 1-2/3 stops.

Important: The above are only approximate guidelines. Exact exposure determination is extremely difficult, especially with reversal color films. Therefore, it is advisable to make several different exposures for each subject to be sure of getting one that is correct.

Fisheye-Nikkor Auto 8mm f/2.8

Because of its wide picture angle (180°), the Fisheye-Nikkor is susceptible to inflated exposure readings due to direct sunlight. To compensate, open up the lens two stops.

Your Photomic FT_N Finder is ruggedly constructed. However, it deserves the same care you would give any precision instrument. Follow the simple precautions given below and the Photomic FT_N will give years of dependable service.

- Store the finder in a case to keep out dust. Avoid storing it in places liable to excessive heat, cold or dampness.
- Attach a prism guard when storing the finder separately.
- To insure most dependable service, clean the battery contact surfaces periodically with a rough cloth.
- Avoid fingerprints and dust particles on the prism surface.
- Brush away grit or dust with a soft brush or use a rubber syringe. Do not use cloth or ordinary tissue.
- If smudges or fingermarks persist, use tissue with a professionally recommended lens cleaner very sparingly. Wipe with a circular motion and gentle pressure. Even an approved cleaner can cause damage if it seeps into the prism mount.
- To insure that the exposure meter will operate properly when needed, it should be checked periodically. Make a few trial exposures before leaving for a holiday. Allow at least two or three weeks' time for processing the test film and making any needed repairs or adjustment. This simple precaution may save a valuable holiday record which would otherwise be lost.

PHOTOMIC FT_N FINDER FEATURES/SPECIFICATIONS

Film speed scale:	ASA 6–6400
Metering range:	EV 2–17 at ASA 100 (1/2 sec at f/1.4–1/1000 sec at f/11 with 50mm f/1.4)
Light measuring method:	Center-weighted, full aperture measurement.
Aperture coupling range:	f/1.2–f/32
Shutter speed coupling range:	1–1/1000 sec, B (2 sec) and T (4 sec). Shutter speed is visible in the finder.
Maximum aperture scale range:	f/1.2–f/5.6
Meter needle:	Visible in the finder and in the window on top of the prism housing.
Meter switch & battery check:	Provided. Battery can also be checked by depressing the switch-off button further than its “off” position.
Battery:	2 mercury batteries (1.3V each)
Weight:	275g (9.5 oz)

THE NIKON WARRANTY

The Nikon Worldwide Service Warranty Registration Card which identifies your Photomic finder by its serial number is your guarantee that the Photomic finder you buy is a new one. When you return this card to a Nikon distributor you will receive your Nikon Worldwide Service Warranty Certificate, which entitles you to a one-year warranty anywhere throughout the world, subject to the conditions listed in the certificate.

Only a franchised Nikon dealer can provide you with a Nikon Warranty Registration Card. We cannot guarantee any camera or lens sold to you by an unauthorized dealer without a Warranty Registration Card, since it may be second-hand equipment.